

Engineering Data

Four-way Cassette VRF IDU



MIH28Q4HN18

MIH90Q4HN18

MIH36Q4HN18

MIH100Q4HN18

MIH45Q4HN18

MIH112Q4HN18

MIH56Q4HN18

MIH140Q4HN18

MIH71Q4HN18

MIH160Q4HN18

MIH80Q4HN18

MIH180Q4HN18

Four-way Cassette

1 Specifications	4
2 Dimensions	8
3 Unit Placement	9
4 Piping Diagram	11
5 Wiring Diagram	12
6 Capacity Tables.....	13
7 Electrical Characteristics.....	14
8 Sound Levels	15
9 Temperature and Airflow Distributions	17

1 Specifications

Table 1.1: MIH28(36,45,56)Q4HN18 specifications

Model			MIH28Q4HN18	MIH36Q4HN18	MIH45Q4HN18	MIH56Q4HN18
Power supply			1-phase, 220-240V, 50/60Hz			
Cooling ¹	Capacity	kW	2.8	3.6	4.5	5.6
		kBtu/h	9.6	12.3	15.4	19.1
	Power input	W	17	17	36	23
Heating ²	Capacity	kW	3.2	4.0	5.0	6.3
		kBtu/h	10.9	13.7	17.1	21.5
	Power input	W	17	17	36	23
Fan motor type			DC			
Indoor coil	Number of rows		1	1	1	2
	Tube pitch × row pitch	mm	18×10.72			
	Fin spacing and type	mm	1.2 Hydrophilic aluminum			
	Tube OD and type	mm	Φ5 Inner-groove			
	Dimensions (L×H×W)	mm	2165×144×10.72			
	Number of circuits		4	4	4	8
Air flow rate ³		m ³ /h	790/740/691/641/591/542/492		910/840/770/701/631/561/491	840/791/741/692/642/593/543
Sound pressure level ⁴		dB(A)	30/29/28/27.5/27/26/25		37/35/34/32/30/29/27	33/32/31/30/29/28/27
Sound power level		dB(A)	44/43/42/42/41/40/39		52/51/49/47/45/43/40	49/48/47/47/46/45/44
Main body	Net dimensions ⁵ (W×H×D)		mm 840×204×840			
	Packed dimensions (W×H×D)		mm 940×250×940			
	Net/Gross weight		kg 18/20.5			19.5/22
Panel	Net dimensions (W×H×D)		mm 950×50×950			
	Packed dimensions (W×H×D)		mm 1020×90×1020			
	Net/Gross weight		kg 5.8/7.6			
Refrigerant type			R410A/R32			
Design pressure (H/L)		MPa	4.4/1.5			
Pipe connections	Liquid/Gas pipe		mm Φ6.35/Φ12.7			
	Drain pipe		mm OD Φ25			

Notes:

- Indoor temperature 27°C DB, 19°C WB; outdoor temperature 35°C DB; equivalent refrigerant piping length 7.5m with zero level difference.
- Indoor temperature 20°C DB; outdoor temperature 7°C DB, 6°C WB; equivalent refrigerant piping length 7.5m with zero level difference.
- Air flow rate are from the highest speed to the lowest speed, total 7 rates for each model.
- Sound pressure level is from highest level to lowest level, total 7 levels for each model. Sound pressure level is measured 1.5m below the unit in a semi-anechoic chamber.
- Unit body dimensions given are the largest external dimensions of the unit, including hanger attachments.

Table 1.2: MIH71(80,90)Q4HN18 specifications

Model			MIH71Q4HN18	MIH80Q4HN18	MIH90Q4HN18
Power supply			1-phase, 220-240V, 50/60Hz		
Cooling ¹	Capacity	kW	7.1	8.0	9.0
		kBtu/h	24.2	27.3	30.7
	Power input	W	32	41	43
Heating ²	Capacity	kW	8.0	9.0	10.0
		kBtu/h	27.3	30.7	34.1
	Power input	W	32	41	43
Fan motor type			DC		
Indoor coil	Number of rows		2	3	2
	Tube pitch × row pitch	mm	18×10.72		
	Fin spacing and type	mm	1.2 Hydrophilic aluminum		
	Tube OD and type	mm	Φ5 Inner-groove		
	Dimensions (L×H×W)	mm	2165×144×21.44		2165×198×21.44
	Number of circuits		8	8	11
Air flow rate ³		m ³ /h	1000/943/886/829/772 /715/658	1100/1019/939/858/777/ 697/616	1330/1239/1148/1057/965 /874/783
Sound pressure level ⁴		dB(A)	37/36/34/33/31/30/28	42.5/40/38/36/34/32/30	38/37/35/34/32/31/29
Sound power level		dB(A)	52/51/50/48/47/45/44	57/55/53/51/49/47/45	55/54/52/51/50/48/47
Main body	Net dimensions ⁵ (W×H×D)	mm	840×204×840		840×246×840
	Packed dimensions (W×H×D)	mm	940×250×940		940×295×940
	Net/Gross weight	kg	19.5/22		21.5/24
Panel	Net dimensions (W×H×D)	mm	950×950×50		
	Packed dimensions (W×H×D)	mm	1020×1020×90		
	Net/Gross weight	kg	5.8/7.6		
Refrigerant type			R410A/R32		
Design pressure (H/L)		MPa	4.4/1.5		
Pipe connections	Liquid/Gas pipe	mm	Φ9.52/Φ15.9		
	Drain pipe	mm	OD Φ25		

Notes:

- Indoor temperature 27°C DB, 19°C WB; outdoor temperature 35°C DB; equivalent refrigerant piping length 5m with zero level difference.
- Indoor temperature 20°C DB; outdoor temperature 7°C DB, 6°C WB; equivalent refrigerant piping length 5m with zero level difference.
- Air flow rate are from the highest speed to the lowest speed, total 7 rates for each model.
- Sound pressure level is from highest level to lowest level, total 7 levels for each model. Sound pressure level is measured 1.5m below the unit in a semi-anechoic chamber.
- Unit body dimensions given are the largest external dimensions of the unit, including hanger attachments.

V8 VRF Indoor Units



Table 1.3: MIH100(112,140)Q4HN18 specifications

Model			MIH100Q4HN18	MIH112Q4HN18	MIH140Q4HN18
Power supply			1-phase, 220-240V, 50/60Hz		
Cooling ¹	Capacity	kW	10.0	11.2	14.0
		kBtu/h	34.1	38.2	47.8
	Power input	W	74	61	118
Heating ²	Capacity	kW	11.2	12.5	16.0
		kBtu/h	38.2	42.7	54.6
	Power input	W	74	61	118
Fan motor type			DC		
Indoor coil	Number of rows		2	2	2
	Tube pitch × row pitch	mm	18×10.72		
	Fin spacing and type	mm	1.2 Hydrophilic aluminum		
	Tube OD and type	mm	Φ5 Inner-groove		
	Dimensions (L×H×W)	mm	2165×198×21.44	2165×252×21.44	
	Number of circuits		11	14	14
Air flow rate ³		m ³ /h	1470/1360/1250/1141/1031/921/811	1600/1497/1393/1290/1186/1083/979	1900/1787/1673/1560/1446/1333/1219
Sound pressure level ⁴		dB(A)	43/41/40/38/36/35/33	41/40/38/37/36/34/33	47.5/46/44/42/40/38/36.5
Sound power level		dB(A)	58/57/55/53/51/49/47	57/56/55/54/53/52/51	64/63/61/60/58/56/54
Main body	Net dimensions ⁵ (W×H×D)	mm	840×246×840	840×288×840	
	Packed dimensions (W×H×D)	mm	940×295×940	940×335×940	
	Net/Gross weight	kg	21.5/24		21.5/24
Panel	Net dimensions (W×H×D)	mm	950×950×50		
	Packed dimensions (W×H×D)	mm	1020×1020×90		
	Net/Gross weight	kg	5.8/7.6		
Refrigerant type			R410A/R32		
Design pressure (H/L)		MPa	4.4/1.5		
Pipe connections	Liquid/Gas pipe	mm	Φ9.52/Φ15.9		
	Drain pipe	mm	OD Φ25		

Notes:

- Indoor temperature 27°C DB, 19°C WB; outdoor temperature 35°C DB; equivalent refrigerant piping length 7.5m with zero level difference.
- Indoor temperature 20°C DB; outdoor temperature 7°C DB, 6°C WB; equivalent refrigerant piping length 7.5m with zero level difference.
- Air flow rate are from the highest speed to the lowest speed, total 7 rates for each model.
- Sound pressure level is from highest level to lowest level, total 7 levels for each model. Sound pressure level is measured 1.5m below the unit in a semi-anechoic chamber.
- Unit body dimensions given are the largest external dimensions of the unit, including hanger attachments.

Table 1.4: MIH160(180)Q4HN18 specifications

Model			MIH160Q4HN18	MIH180Q4HN18
Power supply			1-phase, 220-240V, 50/60Hz	
Cooling ¹	Capacity	kW	16.0	18.0
		kBtu/h	54.6	61.4
	Power input	W	110.0	145.0
Heating ²	Capacity	kW	18.0	20.0
		kBtu/h	61.4	68.2
	Power input	W	110.0	145.0
Fan motor type			DC	
Indoor coil	Number of rows		3	3
	Tube pitch × row pitch	mm	18×10.72	
	Fin spacing and type	mm	1.2 Hydrophilic aluminum	
	Tube OD and type	mm	Φ5 Inner-groove	
	Dimensions (L×H×W)	mm	2165×144×10.72	2165×144×10.72
	Number of circuits		14	14
Air flow rate ³		m ³ /h	2100/1900/1760/1630/1500/1380 /1270	2300/2140/1960/1770/1600/143 0/1270
Sound pressure level ⁴		dB(A)	48/46/44/43/41/39/37	52/49/47/45/42/39/38
Sound power level		dB(A)	56/53/51/49/47/46/45	59/56/54/51/49/46/45
Main body	Net dimensions ⁵ (W×H×D)	mm	950×300×950	950×300×950
	Packed dimensions (W×H×D)	mm	1050×335×1050	1050×335×1050
	Net/Gross weight	kg	32.6/37.2	32.7/37.3
Panel	Net dimensions (W×H×D)	mm	1050×65×1050	1050×65×1050
	Packed dimensions (W×H×D)	mm	1115×100×1115	1115×100×1115
	Net/Gross weight	kg	7.4/9.7	7.4/9.7
Refrigerant type			R410A/R32	
Design pressure (H/L)		MPa	4.4/1.5	
Pipe connections	Liquid/Gas pipe	mm	Φ9.52/Φ15.9	Φ9.52/Φ19.1
	Drain pipe	mm	OD Φ25	

- Notes:
- Indoor temperature 27°C DB, 19°C WB; outdoor temperature 35°C DB; equivalent refrigerant piping length 7.5m with zero level difference.
 - Indoor temperature 20°C DB; outdoor temperature 7°C DB, 6°C WB; equivalent refrigerant piping length 7.5m with zero level difference.
 - Air flow rate are from the highest speed to the lowest speed, total 7 rates for each model.
 - Sound pressure level is from highest level to lowest level, total 7 levels for each model. Sound pressure level is measured 1.5m below the unit in a semi-anechoic chamber.
 - Unit body dimensions given are the largest external dimensions of the unit, including hanger attachments.

2 Dimensions

2.1 Unit Dimensions

Figure 2.1: 2.8-14.0kW Four-way Cassette dimensions (unit: mm)

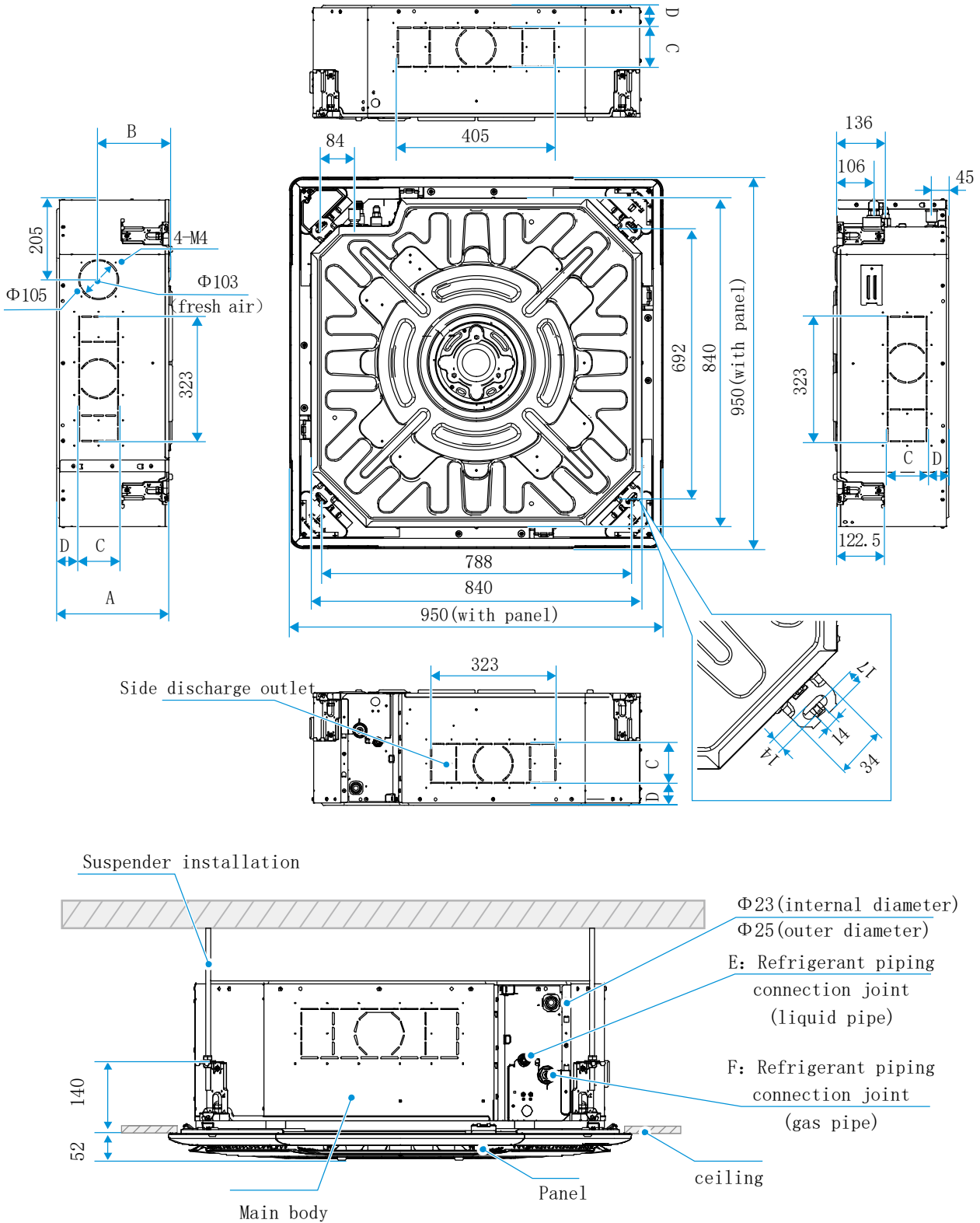

Table 2.1: 2.8-14.0kW Four-way Cassette dimensions (unit: mm)

Model(kW)	A	B	C	D	E	F
2.8~5.6	204	141	63	41.5	$\Phi 12.7$	$\Phi 6.35$
7.1~8.0	204	141	63	41.5	$\Phi 15.9$	$\Phi 9.52$
9.0~10.0	246	163	103	41.5	$\Phi 15.9$	$\Phi 9.52$
11.2~14.0	288	190	103	56.5	$\Phi 15.9$	$\Phi 9.52$

2.2 Unit Dimensions

Figure 2.1: 16.0-18.0kW Four-way Cassette dimensions (unit: mm)

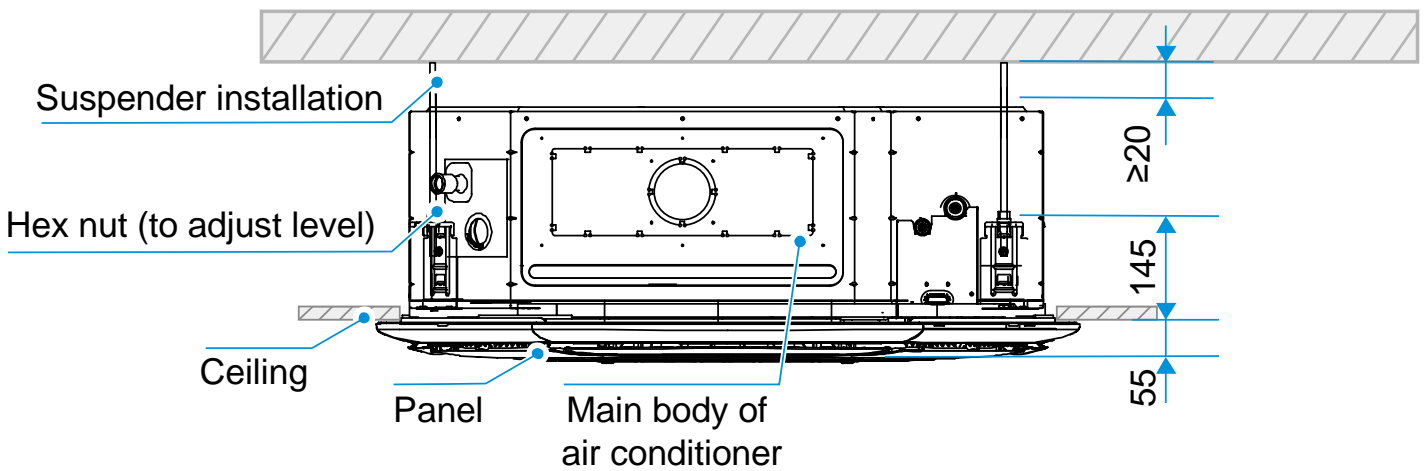
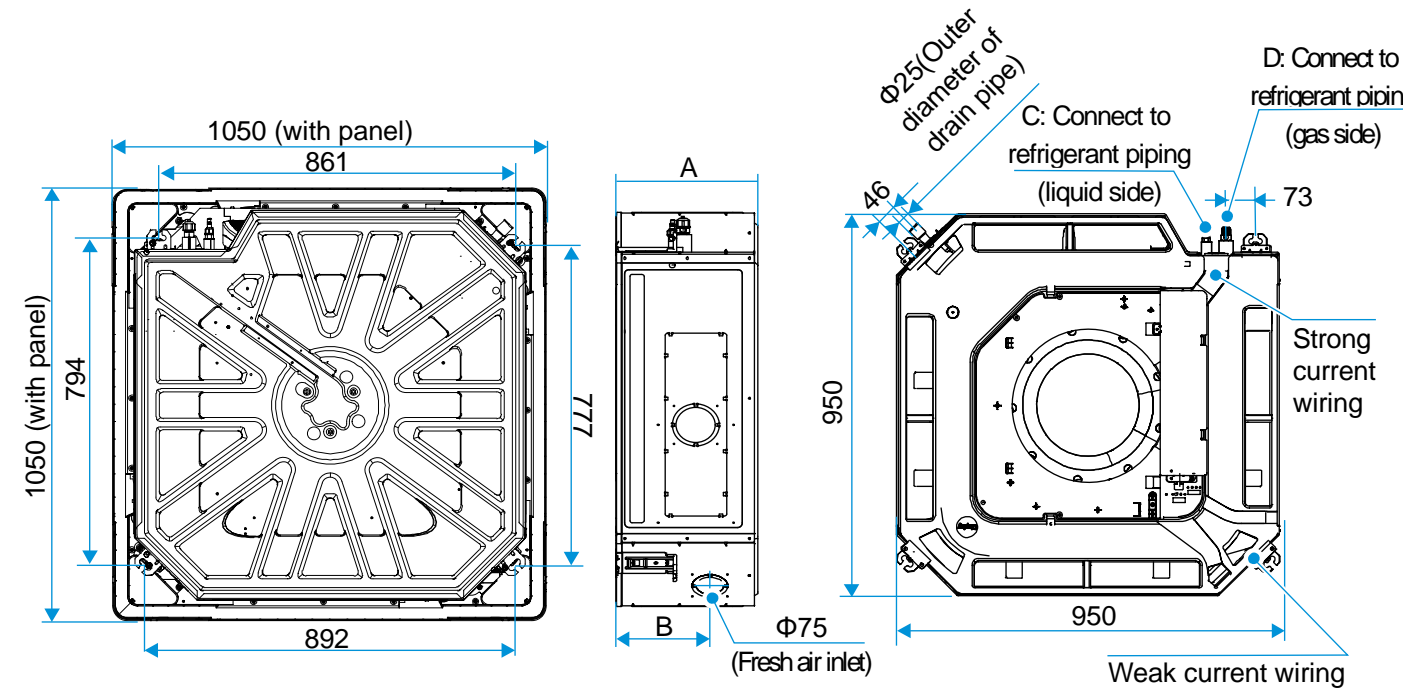

Table 2.1: 16.0-18.0kW Four-way Cassette dimensions (unit: mm)

Model(kW)	A	B	C	D
16.0	300	200	$\Phi 9.5$	$\Phi 15.9$
18.0	300	200	$\Phi 9.5$	$\Phi 19.1$

3 Unit Placement

3.1 Placement Considerations

Unit placement should take account of the following considerations:

- Units should not be installed in the following locations:
 - A place filled with mineral oil, fumes or mist, like a kitchen.
 - A place where there are corrosive gases, such as acid or alkaline gases..
 - A place exposed to combustible gases and using volatile combustible gases such as diluent or gasoline.
 - A place where there is equipment emitting electromagnetic radiation.
 - A place where there is a high salt content in the air like a coast.
 - Do not use the air conditioner in an environment where an explosion may occur.
 - Places like in vehicles or cabin rooms.
 - Factories with major voltage fluctuations in the power supplies.
 - Other special environmental conditions.
- Units should be installed in positions where:
 - Ensure that the airflow in and out of the IDU is reasonably organized to form an air circulation in the room.
 - Ensure IDU maintenance space.
 - The nearer the drainage pipe and copper pipe are to the ODU, the lower the pipe cost is.
 - Prevent the air conditioner from blowing directly to the human body.
 - The closer the wiring to the power cabinet, the lower the wiring cost is.
 - Keep the air-conditioning return air away from the setting sun of the room.
 - Be careful not to interfere with the light tank, fire pipe, gas pipe and other facilities.
 - The IDU should not be lifted in the places like load-bearing beam and columns that affect the structural safety of the house.
 - The wired controller and the IDU should be in the same installation space; otherwise, the sampling point setting of the wired controller need to be changed.

3.2 Space Requirements

Figure 3.1: Four-way Cassette space requirements (unit: mm)

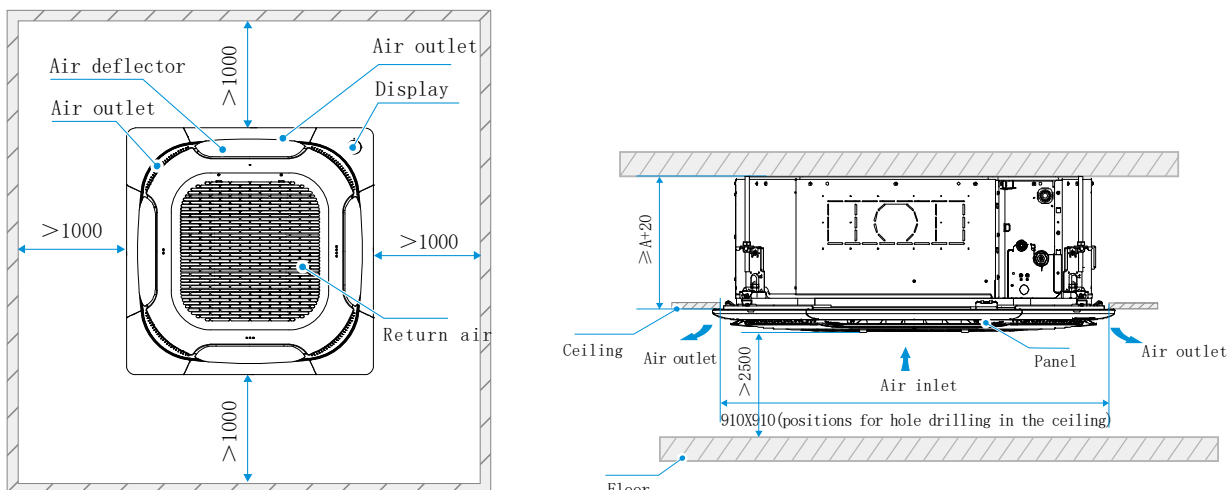

Notes:

1. The centerline of the maintenance hole should be in the same position as the centerline of the indoor unit.
2. The dimensions of A are shown in Table 2,1

4 Piping Diagram

Figure 4.1: Four-way Cassette piping diagram

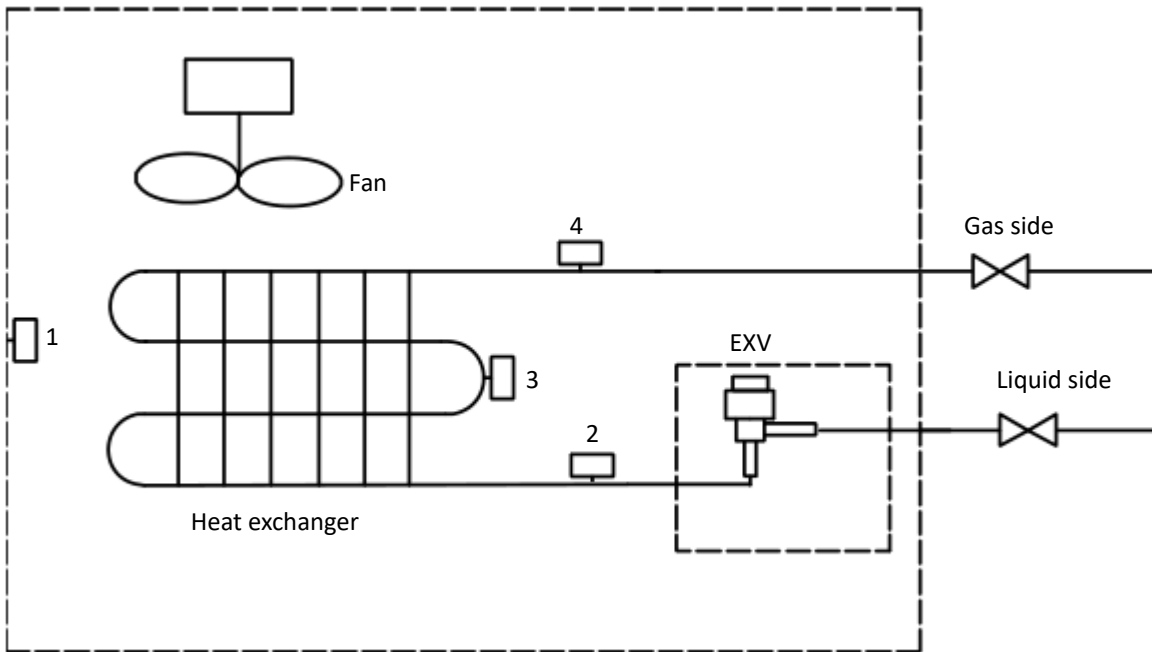

Legend		
1	T1	Indoor ambient temperature sensor
2	T2A	Indoor heat exchanger liquid side temperature sensor
3	T2	Indoor heat exchanger mid-point temperature sensor
4	T2B	Indoor heat exchanger gas side temperature sensor

5 Wiring Diagram

Figure 5.1: Four-way Cassette wiring diagram

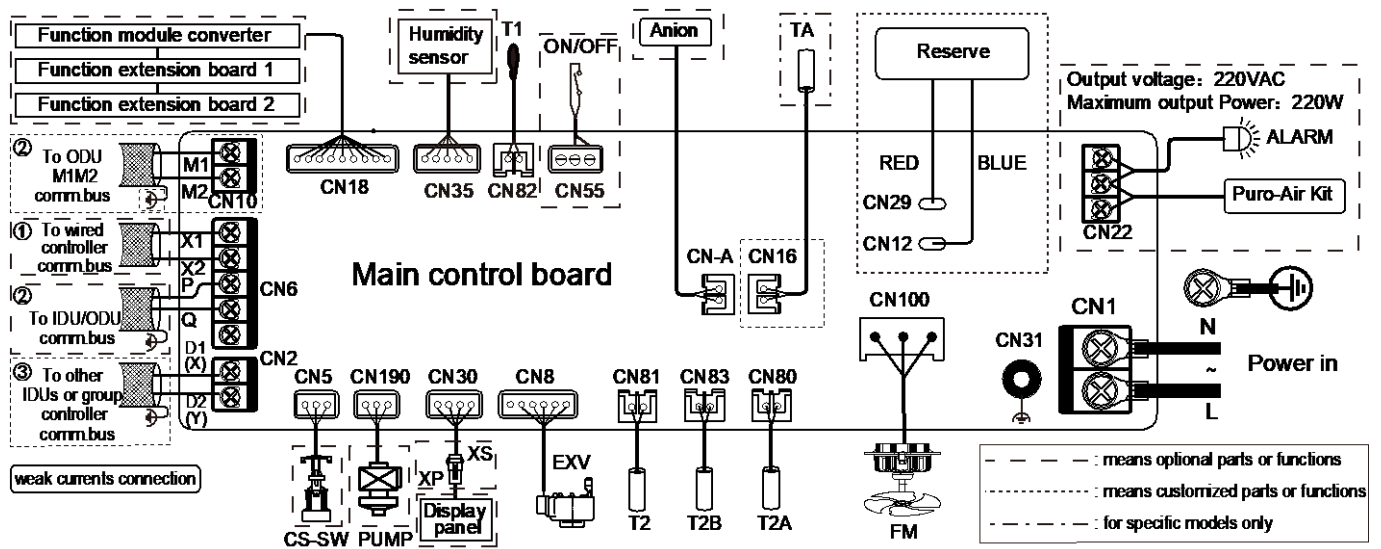

Notes for installers and service engineers

Caution

- All installation, servicing and maintenance must be carried out by competent and suitably qualified, certified and accredited professionals and in accordance with all applicable legislation.
- Units should be grounded in accordance with all applicable legislation. Metal and other conductive components should be insulated in accordance with all applicable legislation.
- Power supply wiring should be securely fastened at the power supply terminals – loose power supply wiring would represent a fire risk.
- After installation, servicing or maintenance, the electric control box cover should be closed. Failing to close the electric control box cover risks fire or electric shock.
- The dotted lines indicate the field wiring or optional function.
- PQ and M1M2 communication ports both are used for indoor and outdoor communication, and only one of them can be used at a time. Meanwhile, be sure to connect the same communication ports (PQ to PQ; M1M2 to M1M2) in case of damage of the main control board.
- D1D2 communication ports are used for group control communication. When connecting the group controller, the D1D2 port of the indoor units that are to be group controlled must be connected in daisy chain, and the group controller must be connected to the X1X2 port of one of the indoor units in the group control, and set to group control mode. In addition, D1D2 communication ports can also be connected to the central controller.

6 Capacity Tables

6.1 Cooling Capacity Table

Table 6.1: Four-way Cassette cooling capacity

Model	Indoor air temperature (°C WB/DB)													
	14/20		16/23		18/26		19/27		20/28		22/30		24/32	
	TC	SC	TC	SC	TC	SC	TC	SC	TC	SC	TC	SC	TC	SC
MIH28Q4HN18	2.5	2.5	2.7	2.6	2.8	2.5	2.8	2.4	2.9	2.4	2.9	2.2	3.0	2.1
MIH36Q4HN18	3.2	3.2	3.4	3.2	3.6	3.2	3.6	3.0	3.7	3.0	3.8	2.8	3.9	2.7
MIH45Q4HN18	4.0	4.0	4.3	4.1	4.5	4.0	4.5	3.8	4.6	3.7	4.7	3.5	4.8	3.3
MIH56Q4HN18	5.0	4.8	5.3	4.8	5.6	4.8	5.6	4.6	5.7	4.5	5.8	4.2	6.0	4.1
MIH71Q4HN18	6.3	6.1	6.7	6.1	7.0	6.0	7.1	5.8	7.2	5.7	7.4	5.4	7.6	5.2
MIH80Q4HN18	7.1	6.9	7.6	6.9	7.9	6.8	8.0	6.6	8.1	6.4	8.3	6.1	8.5	5.8
MIH90Q4HN18	8.0	7.7	8.5	7.7	8.9	7.6	9.0	7.4	9.1	7.1	9.4	6.8	9.6	6.5
MIH100Q4HN18	8.9	8.6	9.5	8.6	9.9	8.5	10.0	8.2	10.1	8.0	10.4	7.6	10.6	7.2
MIH112Q4HN18	9.9	9.5	10.6	9.5	11.1	9.5	11.2	9.1	11.3	8.8	11.6	8.4	11.9	8.1
MIH140Q4HN18	12.4	12.0	13.2	12.0	13.8	11.9	14.0	11.5	14.2	11.2	14.5	10.6	14.9	10.1
MIH160Q4HN18	14.2	12.7	15.1	12.5	15.8	12.4	16.0	12.0	16.2	11.8	16.6	11.0	17.0	10.3
MIH180Q4HN18	15.9	14.3	17.0	14.3	17.8	14.3	18.0	14.0	18.2	13.5	18.7	12.6	19.1	11.8

Abbreviations:

TC: Total capacity (kW)

SC: Sensible capacity(kW)

Notes:

1.Shaded cells indicate rating condition.

6.2 Heating Capacity Table

Table 6.2: Four-way Cassette heating capacity

Model	Indoor air temperature (°C DB)					
	16	18	20	21	22	24
	TC	TC	TC	TC	TC	TC
MIH28Q4HN18	3.4	3.4	3.2	3.1	3.0	2.8
MIH36Q4HN18	4.2	4.2	4.0	3.8	3.8	3.5
MIH45Q4HN18	5.3	5.3	5.0	4.8	4.7	4.4
MIH56Q4HN18	6.7	6.6	6.3	6.1	5.9	5.5
MIH71Q4HN18	8.5	8.4	8.0	7.8	7.5	7.0
MIH80Q4HN18	9.5	9.5	9.0	8.7	8.5	7.8
MIH90Q4HN18	10.6	10.5	10.0	9.7	9.4	8.8
MIH100Q4HN18	11.8	11.7	11.1	10.8	10.4	9.7
MIH112Q4HN18	13.3	13.1	12.5	12.1	11.8	10.9
MIH140Q4HN18	17.0	16.8	16.0	15.5	15.0	13.9
MIH160Q4HN18	19.0	18.9	18.0	17.5	17.0	15.8
MIH180Q4HN18	21.0	20.9	20.0	19.5	19.0	17.8

Abbreviations:

TC: Total capacity (kW)

Notes:

1.Shaded cells indicate rating condition.

7 Electrical Characteristics

Table 7.1: Four-way Cassette electrical characteristics

Model name	Power supply						Indoor fan motors	
	Hz	Volts	Min. volts	Max. volts	MCA	MFA	Rated motor output (kW)	FLA
MIH28Q4HN18	50/60	220-240	198	264	0.27	15	0.045	0.22
MIH36Q4HN18	50/60	220-240	198	264	0.27	15	0.045	0.22
MIH45Q4HN18	50/60	220-240	198	264	0.52	15	0.045	0.41
MIH56Q4HN18	50/60	220-240	198	264	0.33	15	0.045	0.26
MIH71Q4HN18	50/60	220-240	198	264	0.42	15	0.045	0.33
MIH80Q4HN18	50/60	220-240	198	264	0.63	15	0.045	0.51
MIH90Q4HN18	50/60	220-240	198	264	0.58	15	0.045	0.46
MIH100Q4HN18	50/60	220-240	198	264	0.91	15	0.045	0.72
MIH112Q4HN18	50/60	220-240	198	264	0.78	15	0.125	0.62
MIH140Q4HN18	50/60	220-240	198	264	1.42	15	0.125	1.10
MIH160Q4HN18	50/60	220-240	198	264	2.30	15	0.125	1.83
MIH180Q4HN18	50/60	220-240	198	264	2.73	15	0.125	2.10

Abbreviations:

MCA: Minimum Circuit Amps

MFA: Maximum Fuse Amps

FLA: Full Load Amps

8 Sound Levels

8.1 Overall

Table 8.1: Four-way Cassette sound pressure levels¹

Model name	Sound pressure levels dB						
	SSH	SH	H	M	L	SL	SSL
MIH28Q4HN18	30	29	28	27.5	27	26	25
MIH36Q4HN18	30	29	28	27.5	27	26	25
MIH45Q4HN18	37	35	34	32	30	29	27
MIH56Q4HN18	33	32	31	30	29	28	27
MIH71Q4HN18	37	36	34	33	31	30	28
MIH80Q4HN18	42.5	40	38	36	34	32	30
MIH90Q4HN18	38	37	35	34	32	31	29
MIH100Q4HN18	43	41	40	38	36	35	33
MIH112Q4HN18	41	40	38	37	36	34	33
MIH140Q4HN18	47.5	46	44	42	40	38	36.5
MIH160Q4HN18	48	46	44	43	41	39	37
MIH180Q4HN18	52	49	47	45	42	39	38

Notes:

1. Sound pressure levels are measured 1.5m below the unit in a semi-anechoic chamber. During in-situ operation, sound pressure levels may be higher as a result of ambient noise.

Figure 8.1: Four-way Cassette sound pressure level measurement

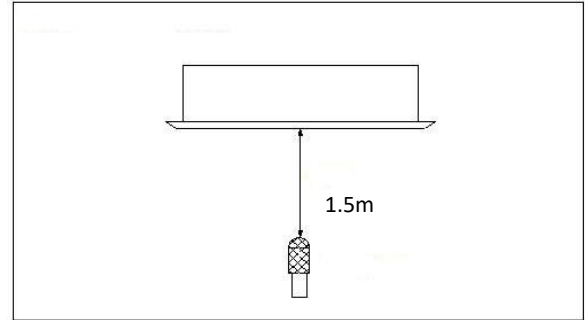

8.2 Octave Band Levels

Figure 8.2: MIH28Q4HN18 octave band levels

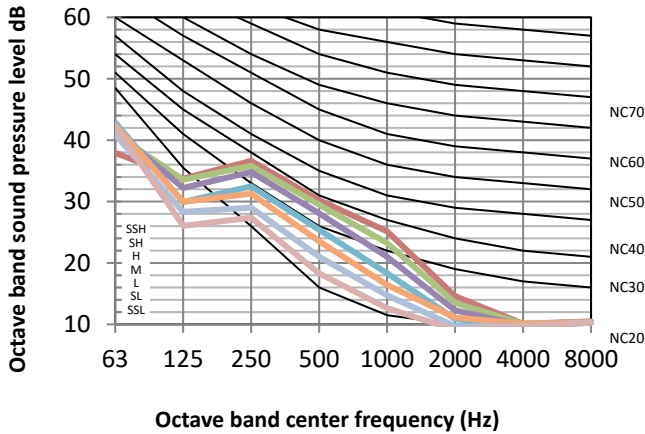

Figure 8.3: MIH36Q4HN18 octave band levels

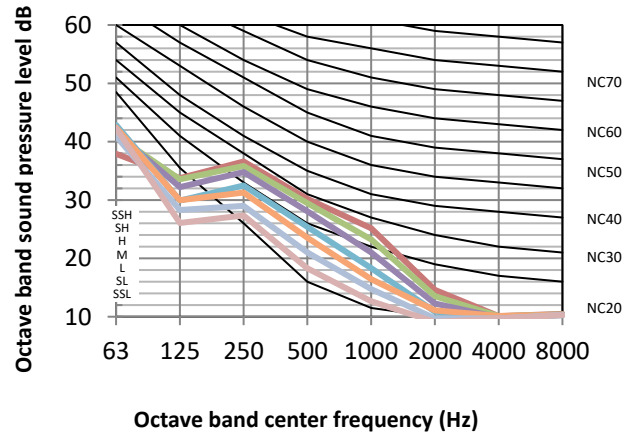

Figure 8.4: MIH45Q4HN18 octave band levels

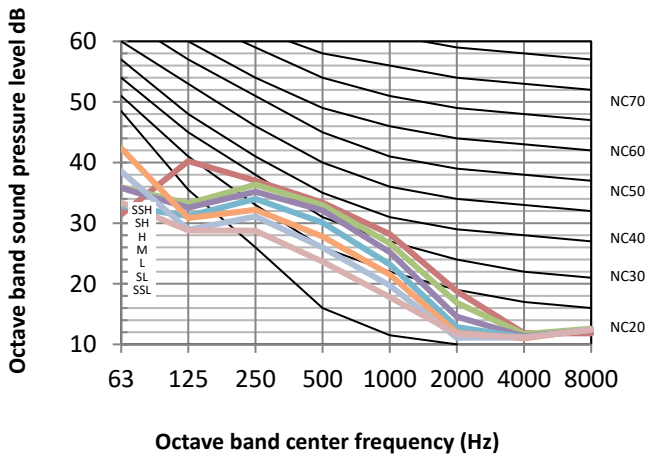

Figure 8.5: MIH56Q4HN18 octave band levels

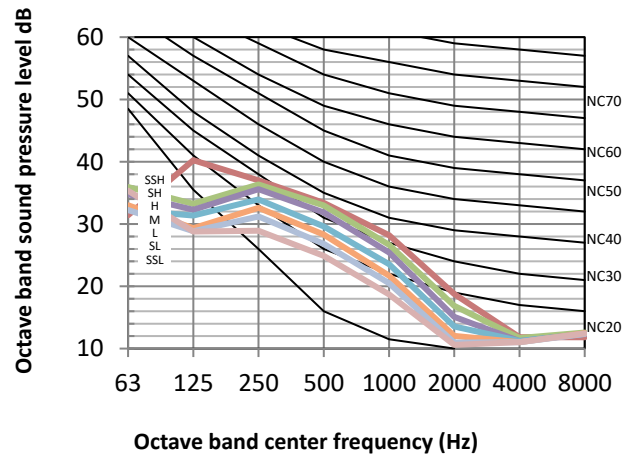

Figure 8.6: MIH71Q4HN18 octave band levels

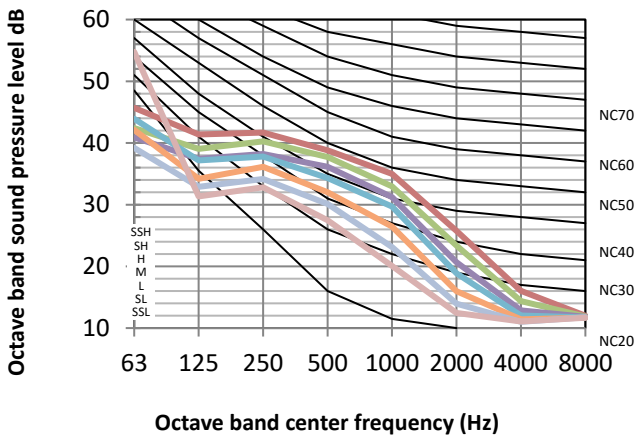

Figure 8.7: MIH80Q4HN18 octave band levels

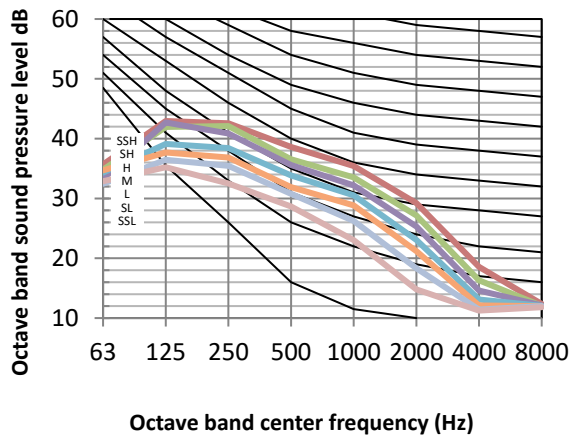

Figure 8.8: MIH90Q4HN18 octave band levels

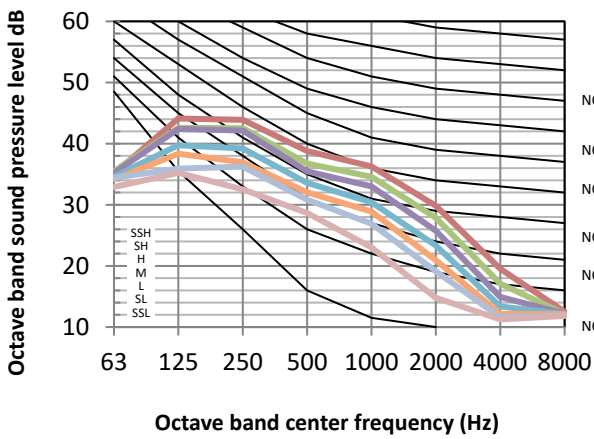

Figure 8.9: MIH100Q4HN18 octave band levels

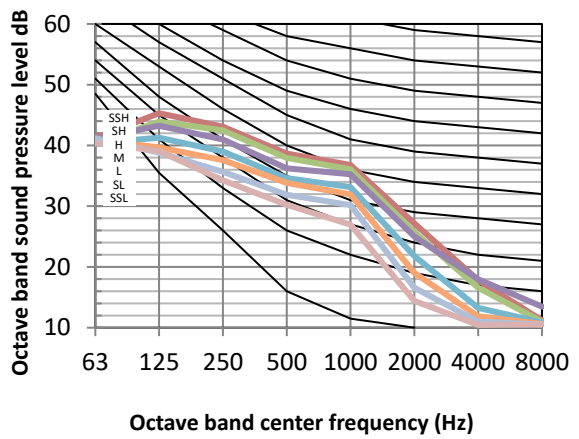

Figure 8.10: MIH112Q4HN18 octave band levels

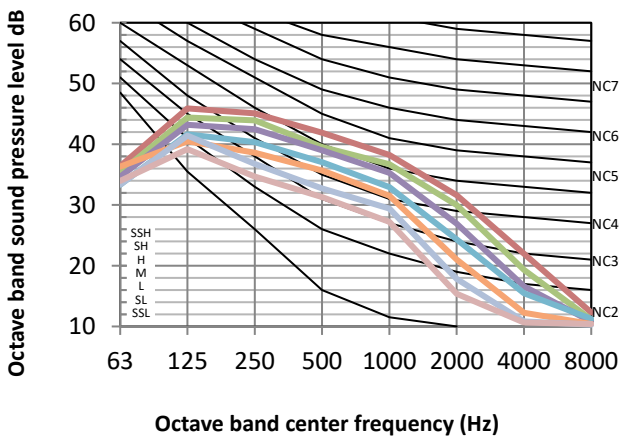

Figure 8.11: MIH140Q4HN18 octave band levels

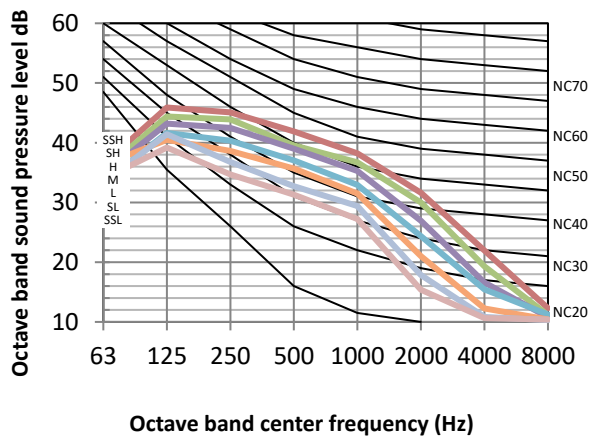

Figure 8.2: MIH28Q4HN18 octave band levels

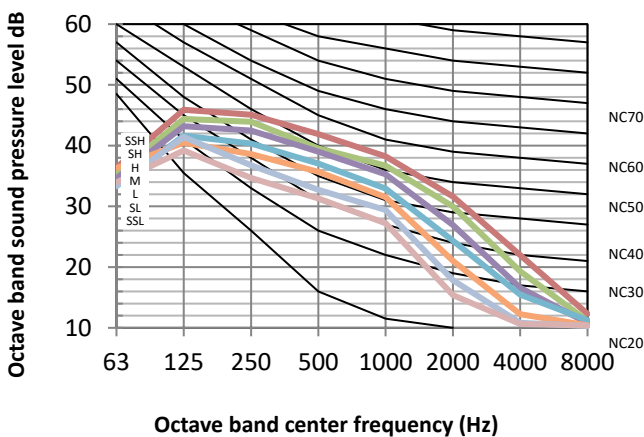
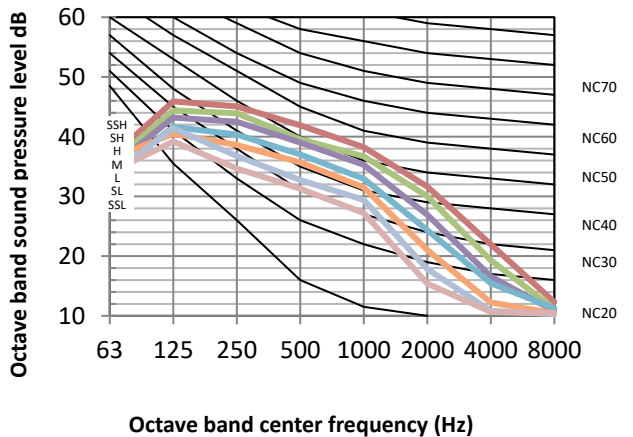

Figure 8.3: MIH36Q4HN18 octave band levels



9 Temperature and Airflow Distributions

9.1 Simulate condition

Table 9.1: Four-way Cassette simulate condition

Model name	Room size (m)	Ceiling height (m)	Flow angle (Cooling/Heating)	Placing
MIH28Q4HN18	6×6	2.7	30° /65°	Center
MIH36Q4HN18	6×6	2.7	30° /65°	Center
MIH45Q4HN18	6×6	2.7	30° /65°	Center
MIH56Q4HN18	8×8	2.7	30° /65°	Center
MIH71Q4HN18	8×8	2.7	30° /65°	Center
MIH80Q4HN18	8×8	2.7	30° /65°	Center
MIH90Q4HN18	10×10	2.7	30° /65°	Center
MIH100Q4HN18	10×10	2.7	30° /65°	Center
MIH112Q4HN18	10×10	2.7	30° /65°	Center
MIH140Q4HN18	10×10	2.7	30° /65°	Center
MIH160Q4HN18	10×10	2.7	30° /65°	Center
MIH180Q4HN18	10×10	2.7	30° /65°	Center

Note:

- These figures and videos are based on software simulation. They show typical temperature and airflow distributions in the conditions above. In the actual installation, they may differ from these figures and videos under the influence of air temperature conditions, ceiling height, cooling/heating load, obstacles, etc.

9.2 Airflow distributions

Figure 9.1: MIH28Q4HN18 cooling at 300s

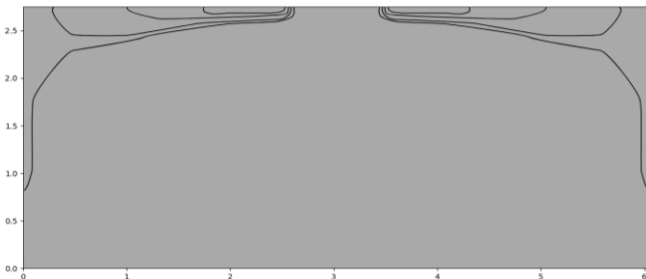

Figure 9.2: MIH28Q4HN18 heating at 300s

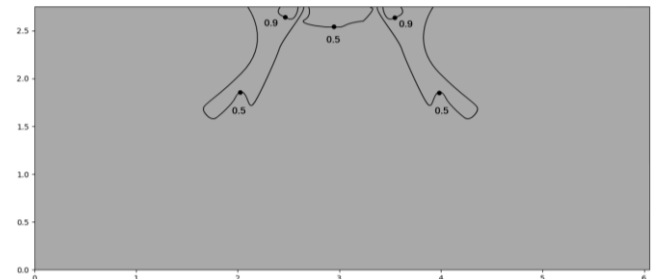

Figure 9.3: MIH36Q4HN18 cooling at 300s

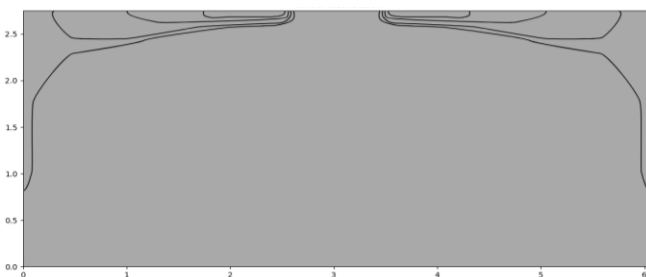

Figure 9.4: MIH36Q4HN18 heating at 300s

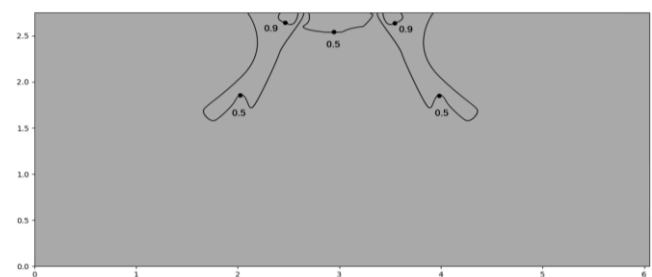

Figure 9.5: MIH45Q4HN18 cooling at 300s

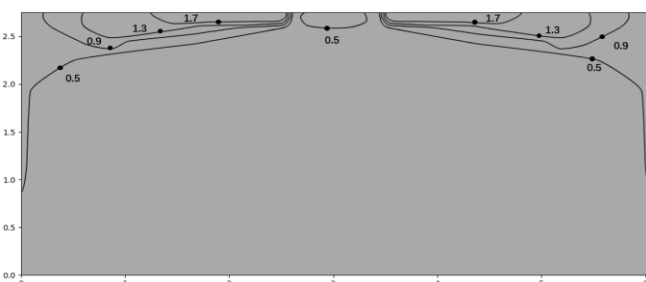

Figure 9.6: MIH45Q4HN18 heating at 300s

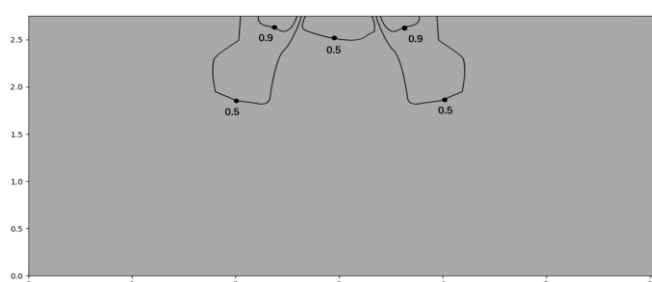

Figure 9.7: MIH56Q4HN18 cooling at 300s

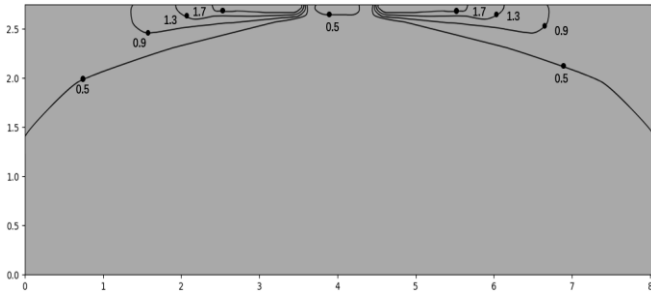

Figure 9.8: MIH56Q4HN18 heating at 300s

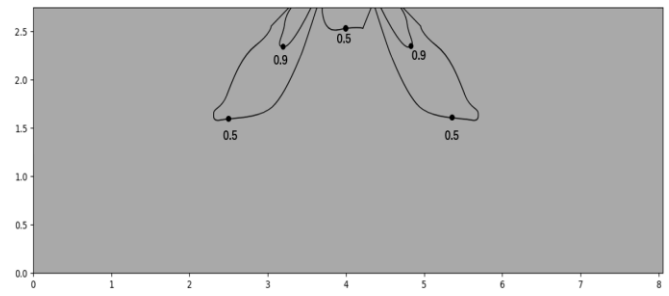

Figure 9.9: MIH71Q4HN18 cooling at 300s

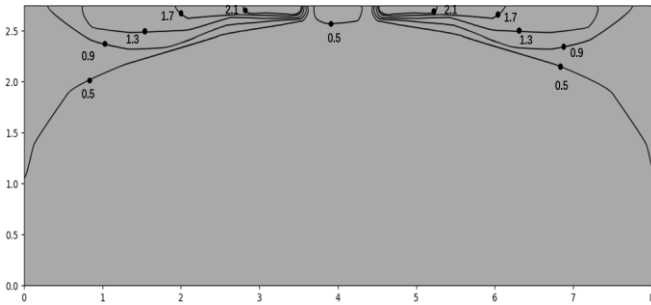

Figure 9.10: MIH71Q4HN18 heating at 300s

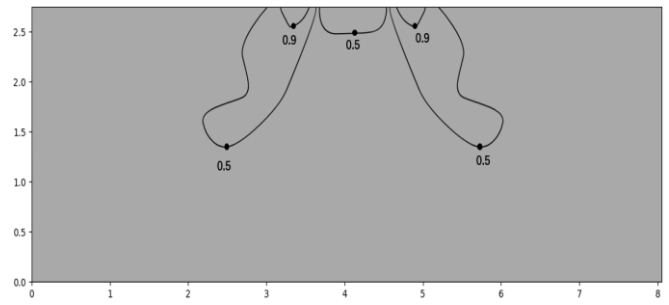

Figure 9.11: MIH80Q4HN18 cooling at 300s

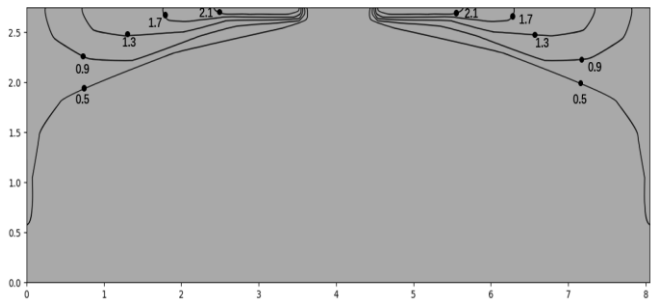

Figure 9.12: MIH80Q4HN18 heating at 300s

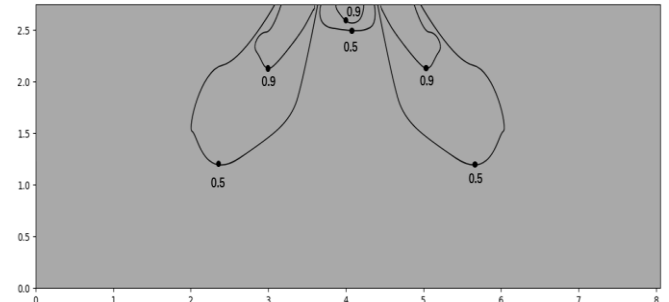

Figure 9.13: MIH90Q4HN18 cooling at 300s

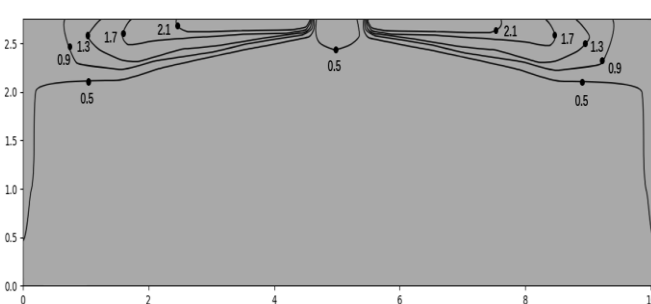

Figure 9.14: MIH90Q4HN18 heating at 300s

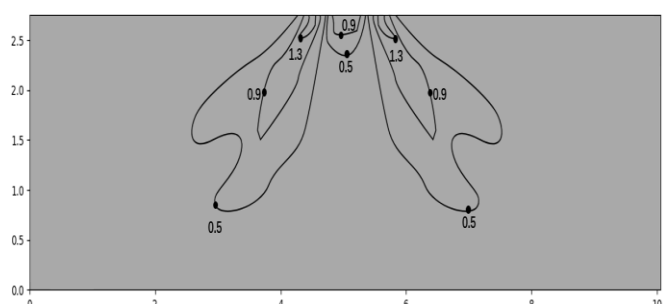

Figure 9.15: MIH100Q4HN18 cooling at 300s

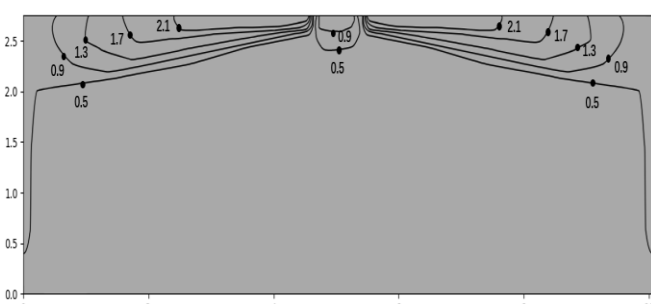

Figure 9.16: MIH100Q4HN18 heating at 300s

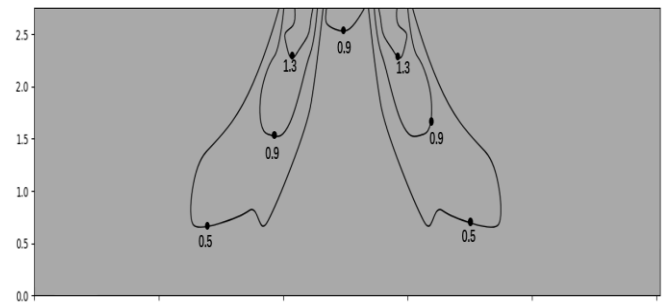

Figure 9.17: MIH112Q4HN18 cooling at 300s

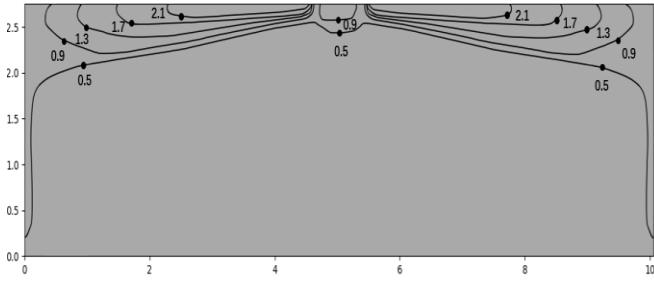

Figure 9.18: MIH112Q4HN18 heating at 300s

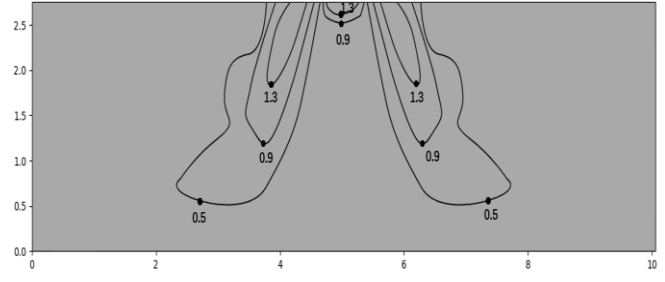

Figure 9.19: MIH140Q4HN18 cooling at 300s

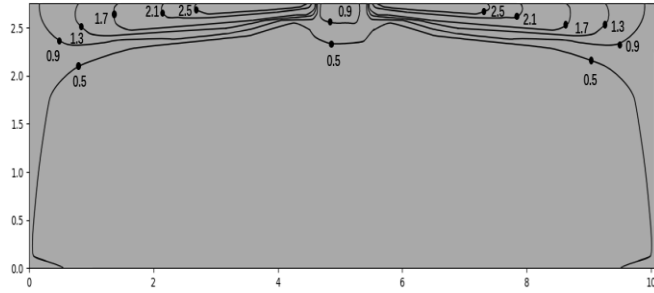

Figure 9.20: MIH140Q4HN18 heating at 300s

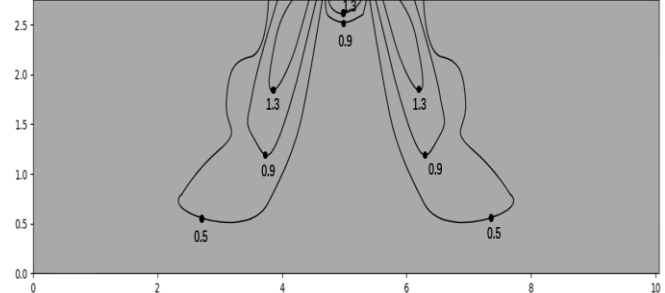

Figure 9.19: MIH160Q4HN18 cooling at 300s

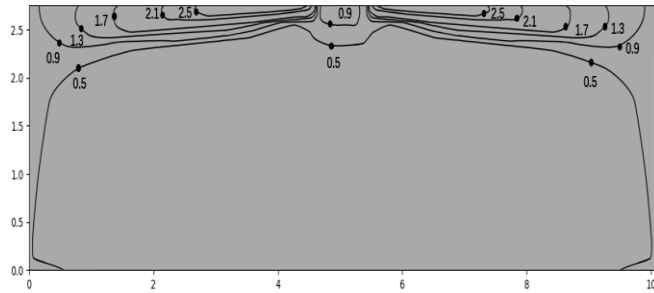

Figure 9.20: MIH160Q4HN18 heating at 300s

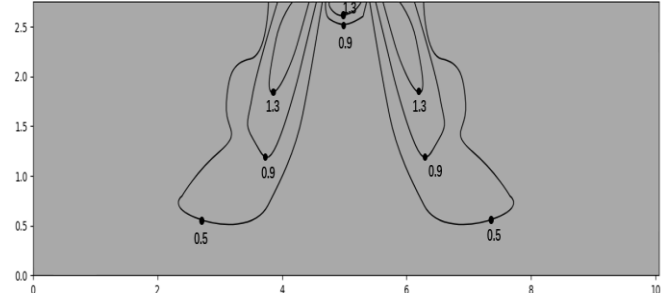

Figure 9.19: MIH180Q4HN18 cooling at 300s

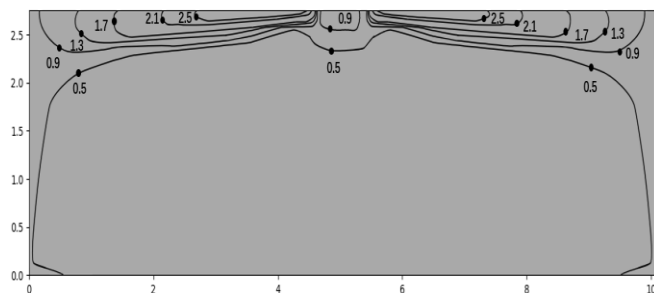
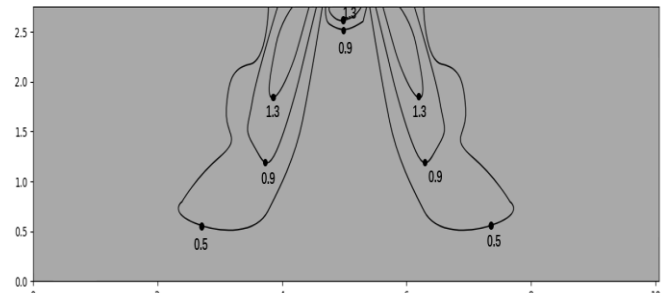

Figure 9.20: MIH180Q4HN18 heating at 300s



9.3 Temperature distributions

Figure 9.21: MIH28Q4HN18 cooling at 300s

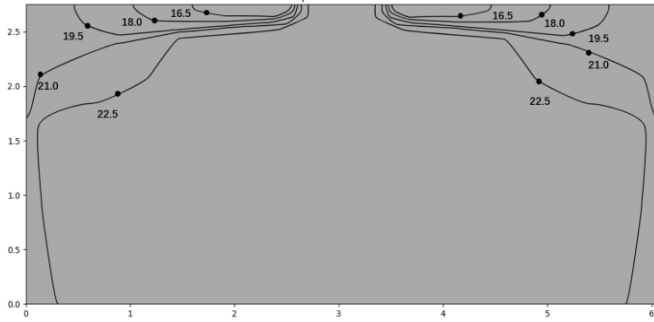

Figure 9.22: MIH28Q4HN18 heating at 300s

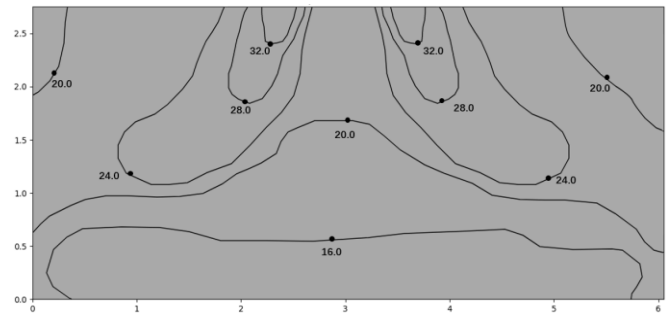

Figure 9.23: MIH36Q4HN18 cooling at 300s

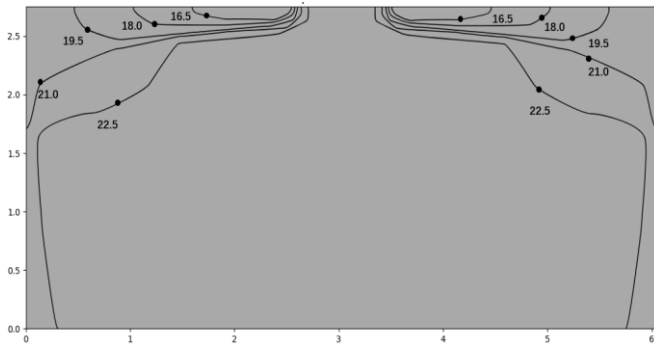

Figure 9.24: MIH36Q4HN18 heating at 300s

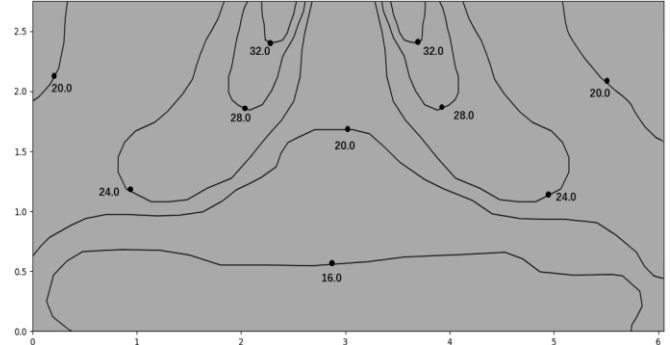

Figure 9.25: MIH45Q4HN18 cooling at 300s

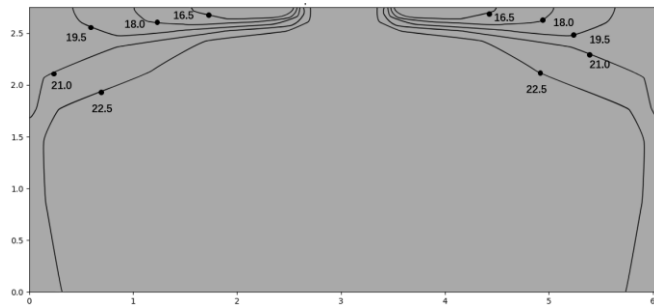

Figure 9.26: MIH45Q4HN18 heating at 300s

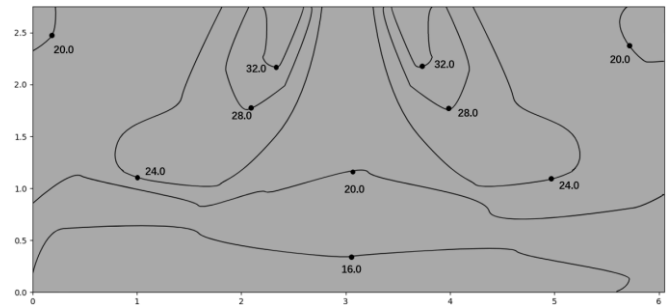

Figure 9.27: MIH56Q4HN18 cooling at 300s

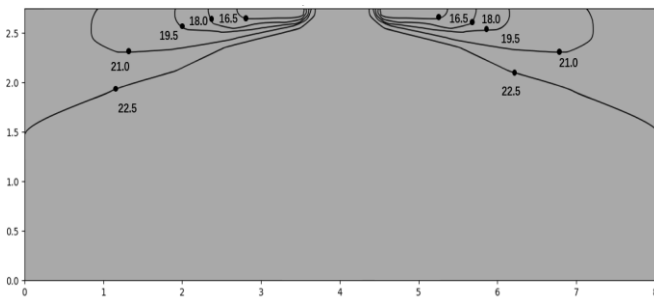

Figure 9.28: MIH56Q4HN18 heating at 300s

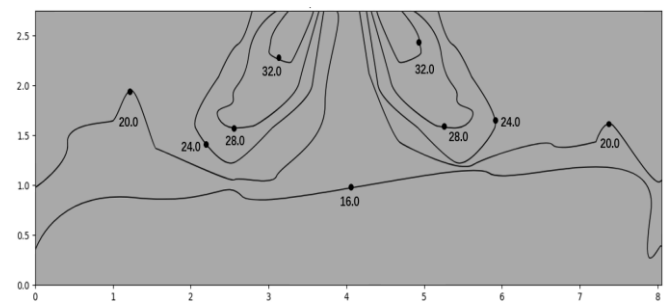

Figure 9.29: MIH71Q4HN18 cooling at 300s

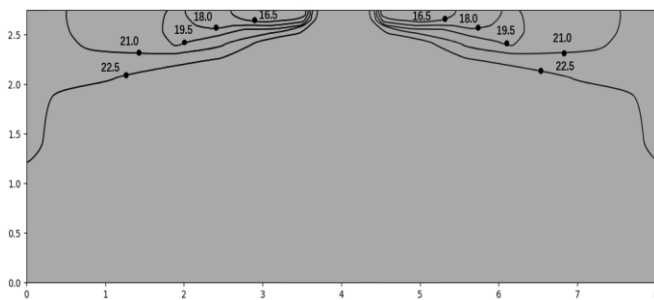

Figure 9.30: MIH71Q4HN18 heating at 300s

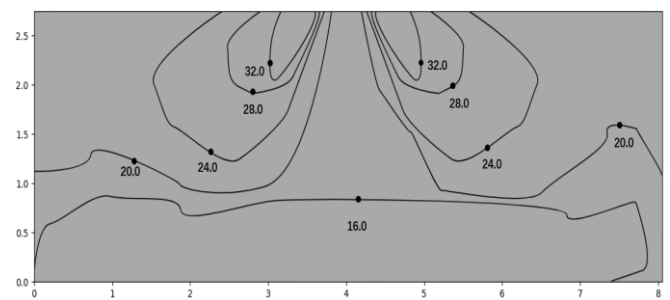

Figure 9.31: MIH80Q4HN18 cooling at 300s

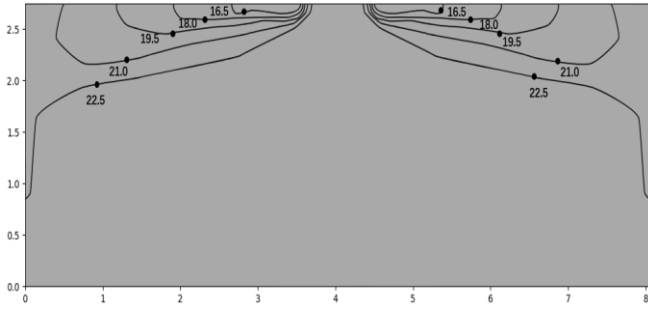

Figure 9.32: MIH80Q4HN18 heating at 300s

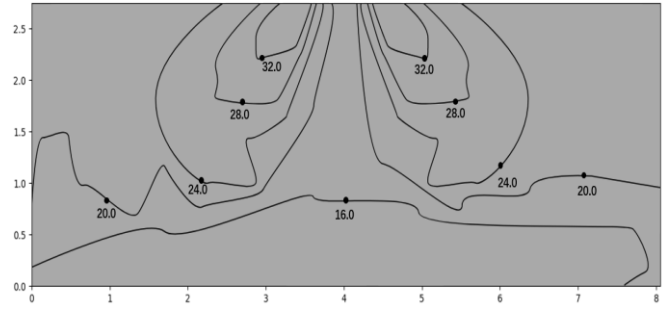

Figure 9.33: MIH90Q4HN18 cooling at 300s

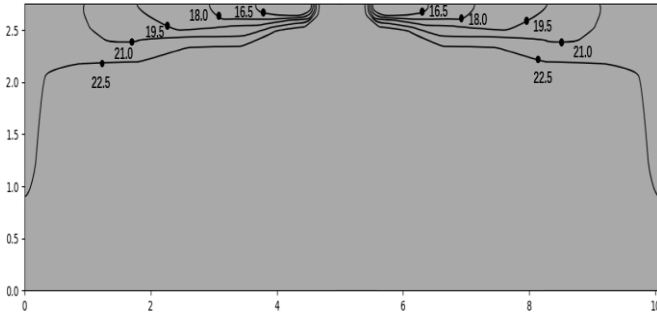

Figure 9.34: MIH90Q4HN18 heating at 300s

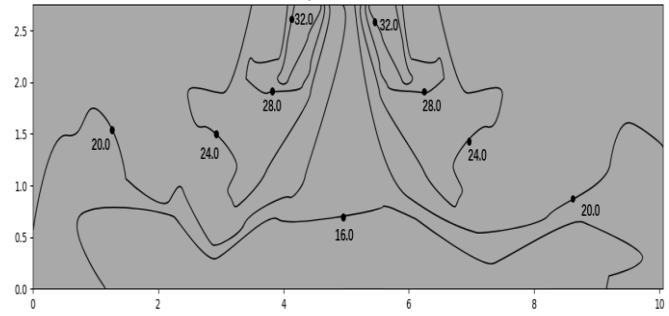

Figure 9.35: MIH100Q4HN18 cooling at 300s

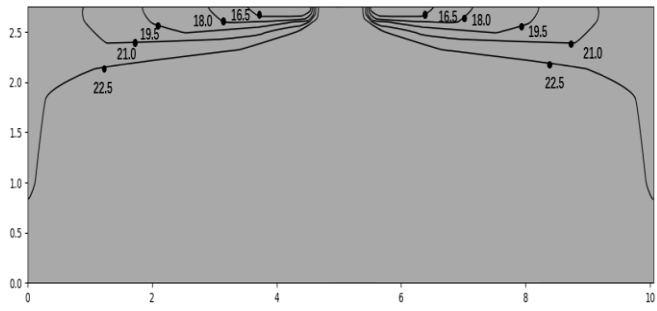

Figure 9.36: MIH100Q4HN18 heating at 300s

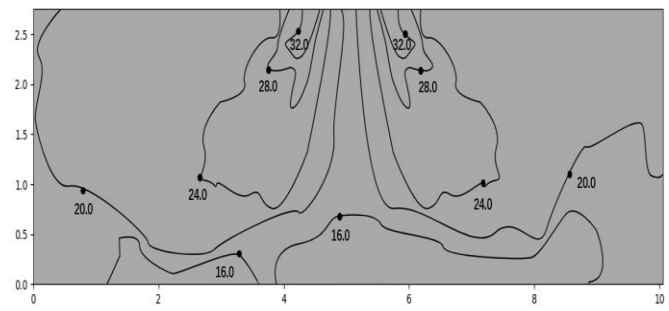

Figure 9.37: MIH112Q4HN18 cooling at 300s

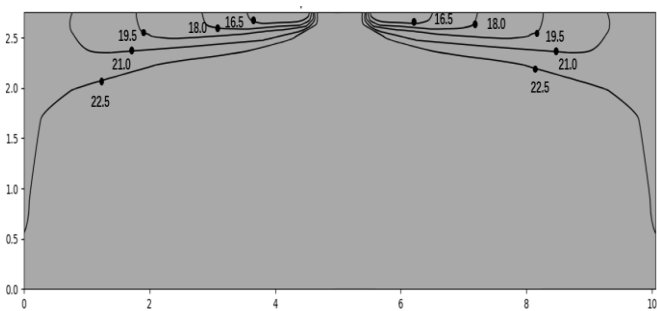

Figure 9.38: MIH112Q4HN18 heating at 300s

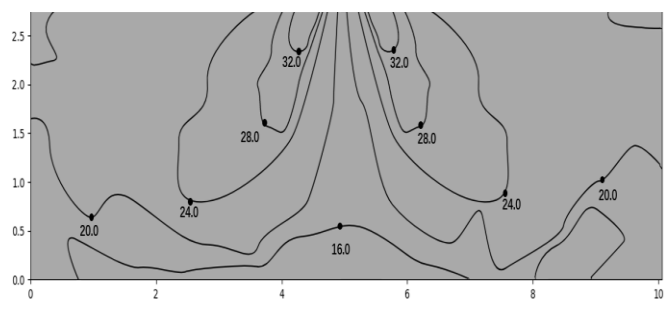

Figure 9.39: MIH140Q4HN18 cooling at 300s

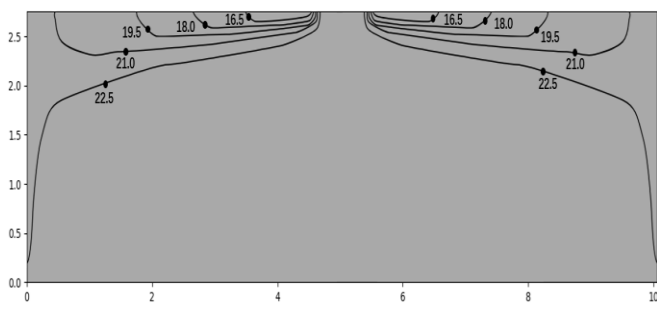

Figure 9.40: MIH140Q4HN18 heating at 300s

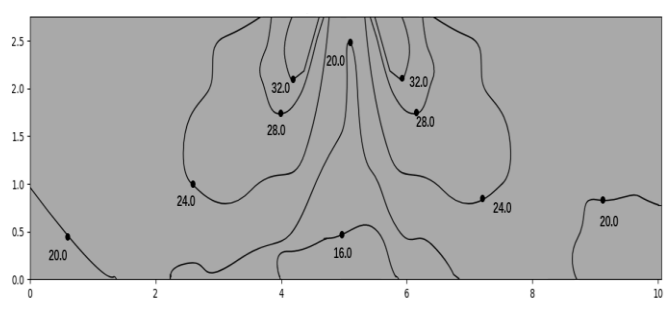

Figure 9.39: MIH160Q4HN18 cooling at 300s

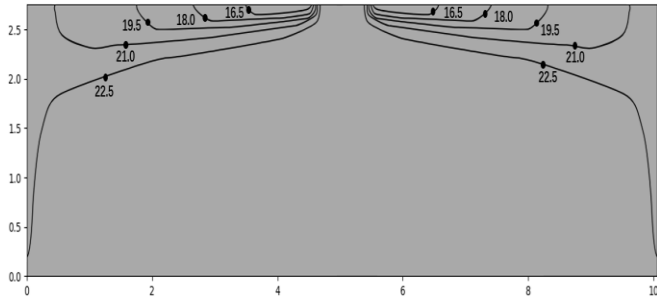

Figure 9.40: MIH160Q4HN18 heating at 300s

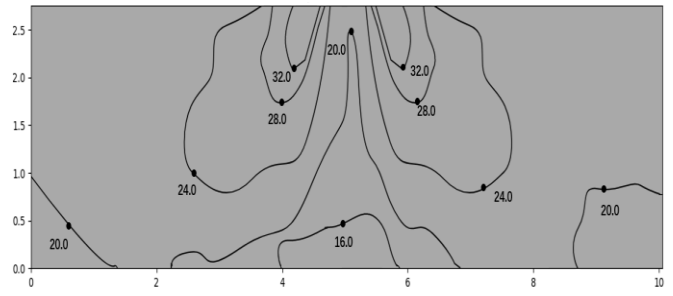

Figure 9.39: MIH180Q4HN18 cooling at 300s

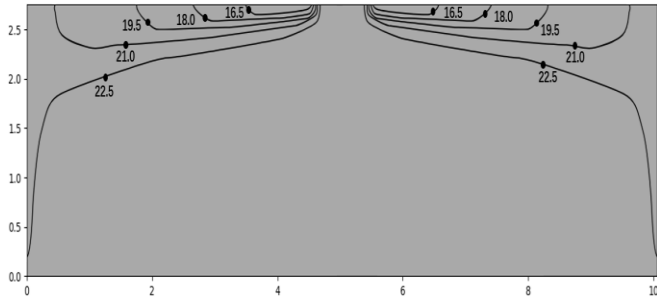
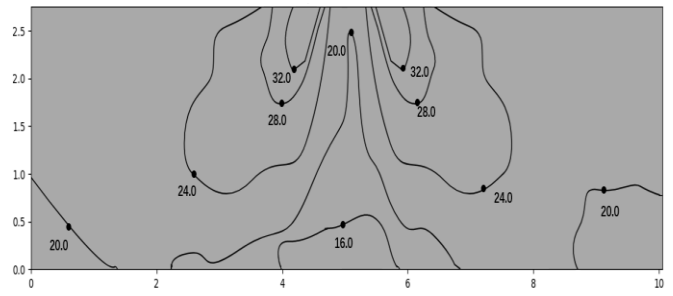

Figure 9.40: MIH180Q4HN18 heating at 300s



Midea Building Technologies Division
Midea Group

Add.: Midea Headquarters Building, 6 Midea Avenue, Shunde, Foshan, Guangdong, China

Postal code: 528311

mbt.midea.com / www.midea-group.com / tsp.midea.com

Note: Product specifications change from time to time as product improvements and developments are released and may vary from those in this document.

